

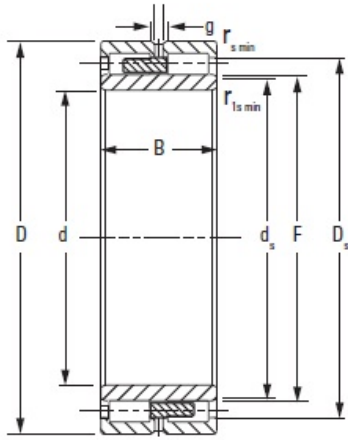

American Precision Parts Co., Ltd.



NNU49/850MAW33 Timken Cylindrical Roller Bearing

Bearing No. NNU49/850MAW33

Bore d	850.000 mm
O.D. D	1120.000 mm
Width B	272.000 mm
DUR/DOR F/E	939.000 mm
Static Load Rating C_0	17900 kN
Dynamic Load Rating C_1^1	6810 kN
Geometry Factor C_g^2	0.4700
Thermal Speed Ratings - Oil	190 rpm
Thermal Speed Ratings - Grease	170 rpm
Weight	794.000 lb
Chamfer r_{smin}	6.00 mm
Chamfer r_{1smin}^3	6.0 mm
Backing Shaft Diameter d_s	928.0 mm
Backing Housing Diameter D_s	1047.0 mm
Lubrication Groove g	25.3 mm
Lubrication Hole Diameter h	13.0 mm
Number of Lubrication Holes	16
Dimension S^4	16.00 mm

NNU49/850MAW33 Bearing 2D drawings and 3D CAD models