

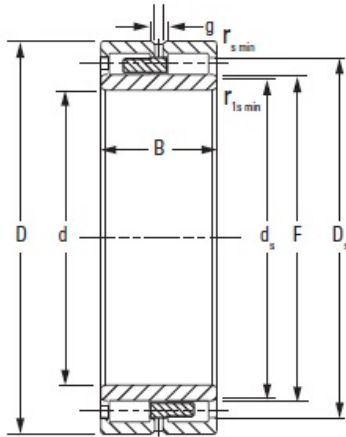

American Precision Parts Co., Ltd.



NNU49/750MAW33 Timken Cylindrical Roller Bearing

Bearing No. NNU49/750MAW33

Bore d	750.000 mm
O.D. D	1000.000 mm
Width B	250.000 mm
DUR/DOR F/E	831.000 mm
Static Load Rating C_0	16480 kN
Dynamic Load Rating C_1^1	6230 kN
Geometry Factor C_g^2	0.4420
Thermal Speed Ratings - Oil	200 rpm
Thermal Speed Ratings - Grease	190 rpm
Weight	1252.200 lb
Chamfer r_{smin}	6.00 mm
Chamfer r_{1smin}^3	6.0 mm
Backing Shaft Diameter d_s	817.9 mm
Backing Housing Diameter D_s	933.0 mm
Lubrication Groove g	19.3 mm
Lubrication Hole Diameter h	9.5 mm
Number of Lubrication Holes	16
Dimension S^4	7.60 mm

NNU49/750MAW33 Bearing 2D drawings and 3D CAD models