

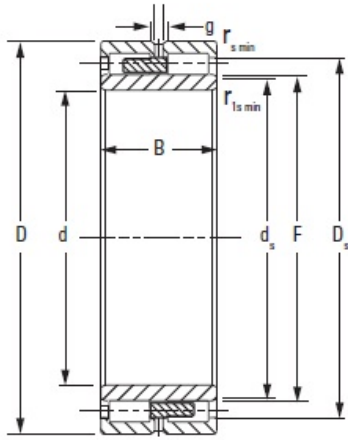

American Precision Parts Co., Ltd.



NNU49/630MAW33 Timken Cylindrical Roller Bearing

Bearing No. NNU49/630MAW33

Bore d	630.000 mm
O.D. D	850.000 mm
Width B	218.000 mm
DUR/DOR F/E	704.000 mm
Static Load Rating C_0	11520 kN
Dynamic Load Rating C_1^1	4570 kN
Geometry Factor C_g^2	0.3830
Thermal Speed Ratings - Oil	270 rpm
Thermal Speed Ratings - Grease	250 rpm
Weight	804.700 lb
Chamfer r_{smin}	6.00 mm
Chamfer r_{1smin}^3	6.0 mm
Backing Shaft Diameter d_s	691.0 mm
Backing Housing Diameter D_s	794.0 mm
Lubrication Groove g	25.3 mm
Lubrication Hole Diameter h	13.0 mm
Number of Lubrication Holes	16
Dimension S^4	9.40 mm

NNU49/630MAW33 Bearing 2D drawings and 3D CAD models