

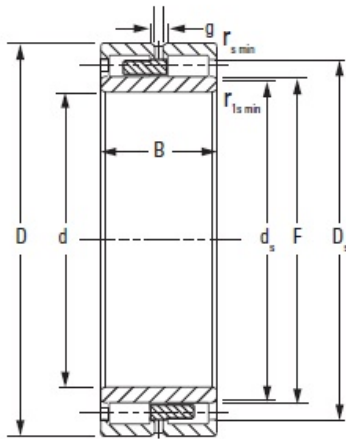

American Precision Parts Co., Ltd.



NNU49/600MAW33 Timken Cylindrical Roller Bearing

Bearing No. NNU49/600MAW33

Bore d	600.000 mm
O.D. D	800.000 mm
Width B	200.000 mm
DUR/DOR F/E	666.000 mm
Static Load Rating C_0	10120 kN
Dynamic Load Rating C_1^1	4040 kN
Geometry Factor C_g^2	0.3650
Thermal Speed Ratings - Oil	290 rpm
Thermal Speed Ratings - Grease	270 rpm
Weight	648.000 lb
Chamfer r_{smin}	5.00 mm
Chamfer r_{1smin}^3	5.0 mm
Backing Shaft Diameter d_s	655.0 mm
Backing Housing Diameter D_s	750.0 mm
Lubrication Groove g	25.3 mm
Lubrication Hole Diameter h	13.0 mm
Number of Lubrication Holes	12
Dimension S^4	6.90 mm

NNU49/600MAW33 Bearing 2D drawings and 3D CAD models