

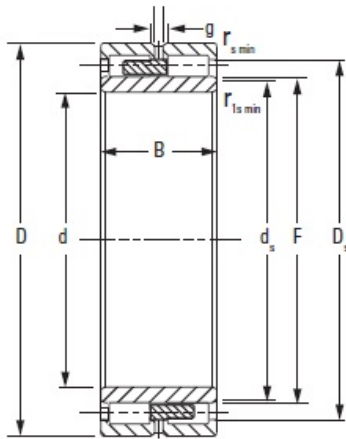

American Precision Parts Co., Ltd.



NNU49/560MAW33 Timken Cylindrical Roller Bearing

Bearing No. NNU49/560MAW33

Bore d	560.000 mm
O.D. D	750.000 mm
Width B	190.000 mm
DUR/DOR F/E	623.000 mm
Static Load Rating C_0	8780 kN
Dynamic Load Rating C_1^1	3590 kN
Geometry Factor C_g^2	0.3460
Thermal Speed Ratings - Oil	330 rpm
Thermal Speed Ratings - Grease	300 rpm
Weight	540.000 lb
Chamfer r_{smin}	5.00 mm
Chamfer r_{1smin}^3	5.0 mm
Backing Shaft Diameter d_s	612.0 mm
Backing Housing Diameter D_s	703.0 mm
Lubrication Groove g	22.0 mm
Lubrication Hole Diameter h	12.0 mm
Number of Lubrication Holes	12
Dimension S^4	6.60 mm

NNU49/560MAW33 Bearing 2D drawings and 3D CAD models